

## North American round style fuses 700V: 35-1200A



### Description

North American round style high speed fuses are rated 700V, extending the range of protection for UPS systems, AC and DC drives, reduced voltage motor starters and similar applications where lower  $I^2t$  and superior reliability are needed. With ratings from 35 to 1200 amperes, a wide range of high voltage applications can be served.

### Ratings

Volts: 700VAC/700VDC

Amps: 35 - 1,200 A

I.R. AC: 100KA @700VAC  
20KA @700VDC

Speed/Characteristic: aR

Body Style: Cylindrical

Material Body: Glass fibre

Contact Materials: Silver plated copper

Environmental RoHS Compliant

### Standards

I EC 60269-1

I EC 60269-4

### Features and Benefits

Low watts loss in a compact size

Used with finger-safe holders/blocks

Lowest  $I^2t$  for greater protection

Excellent cycling ability gives advantage in equipment design

### Typical Applications

DC common bus

DC drives

Power converters/rectifiers

Reduced voltage starters

## North American round style fuses 700V: 35-1200A

### Catalog Numbers

Electrical Characteristics					Ordering Information	
Size	Rated Current	Pre-arcing I <sup>2</sup> t (A <sup>2</sup> s)	Clearing I <sup>2</sup> t @ Rated Voltage (A <sup>2</sup> s)	Watts Loss	Part number	Figure Number
21x109mm	35	40	180	13W	AS21BG-35A	Fig.1
	40	80	340	14W	AS21BG-40A	
	50	145	630	15W	AS21BG-50A	
	60	230	980	16W	AS21BG-60A	
25x114mm	70	350	2100	19W	AS25BG-70A	
	80	370	2500	22W	AS25BG-80A	
	90	430	2800	27W	AS25BG-90A	
	100	570	3600	28W	AS25BG-100A	
38x129mm	125	2000	7600	30W	AS38BG-125A	
	150	3000	12000	33W	AS38BG-150A	
	175	4300	17000	36W	AS38BG-175A	
	200	5500	22000	45W	AS38BG-200A	
51x129mm	225	7900	32000	47W	AS51BG-225A	
	250	11000	42700	50W	AS51BG-250A	
	300	18000	72000	60W	AS51BG-300A	
	350	24000	96000	66W	AS51BG-350A	
	400	32000	125000	80W	AS51BG-400A	
63x180mm	450	36450	138000	97W	AS63BG-450A	
	500	45400	175000	120W	AS63BG-500A	
	600	67000	255000	123W	AS63BG-600A	
75x177mm	700	70000	300000	128W	AS75BG-700A	
	800	78000	450000	143W	AS75BG-800A	
89x193mm	900	92000	530000	150W	AS89BG-900A	Fig.2
	1000	121000	605000	171W	AS89BG-1000A	
108x275mm	1200	197000	1110000	193W	AS108BG-1200A	Fig.3

- Watts loss provided at rated current.
- CE Component Acceptance: 35 - 1200A.

### Dimensions (mm)

Fig.1: 35-800A

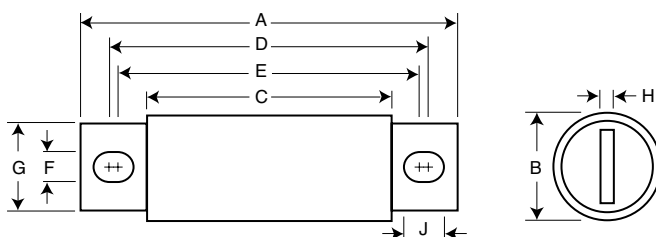

Size	Amp	A	B	C	D	E	F	G	H	J
21x109	35-60A	109	21	68	93	85	8.5	16	4	13
25x114	70-100A	114	25	66	94	90	8.5	18	4	11
38x129	125-200A	129	38	72	108	93	10.5	25	6	18
51x129	225-400A	129	51	72	109	90	10.5	38	6	20
63x180	450-600A	180	63	72	145	110	13.5	50	10	31
75x177	700-800A	177	75	82	140	114	16	60	12	29

1mm = 0.0394" / 1" = 25.4mm

## North American round style fuses 700V: 35-1200A

Fig.2: 900-1000A

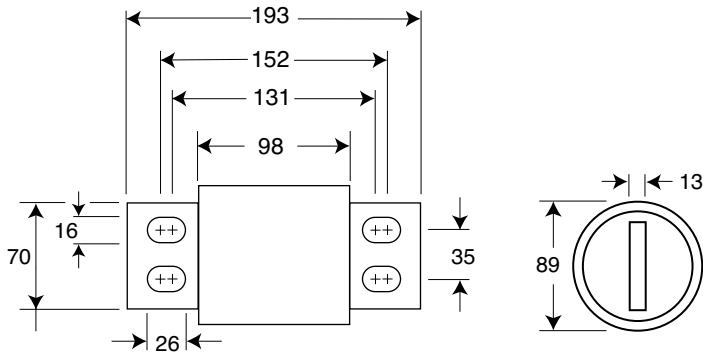
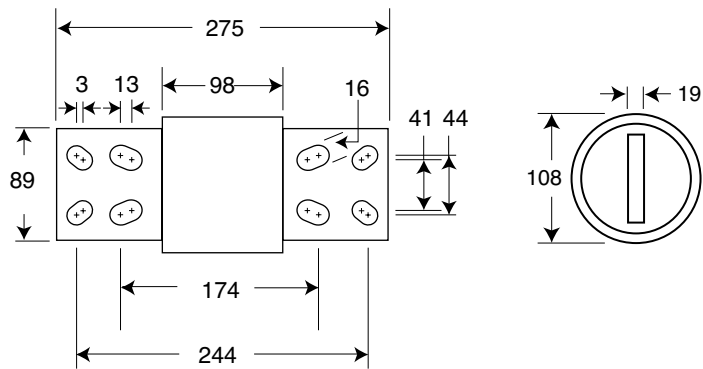

Fig.3: 1200A



# North American round style fuses 700V: 35-1200A

## AS21BG 35-60A: 700V

Time-Current Curve

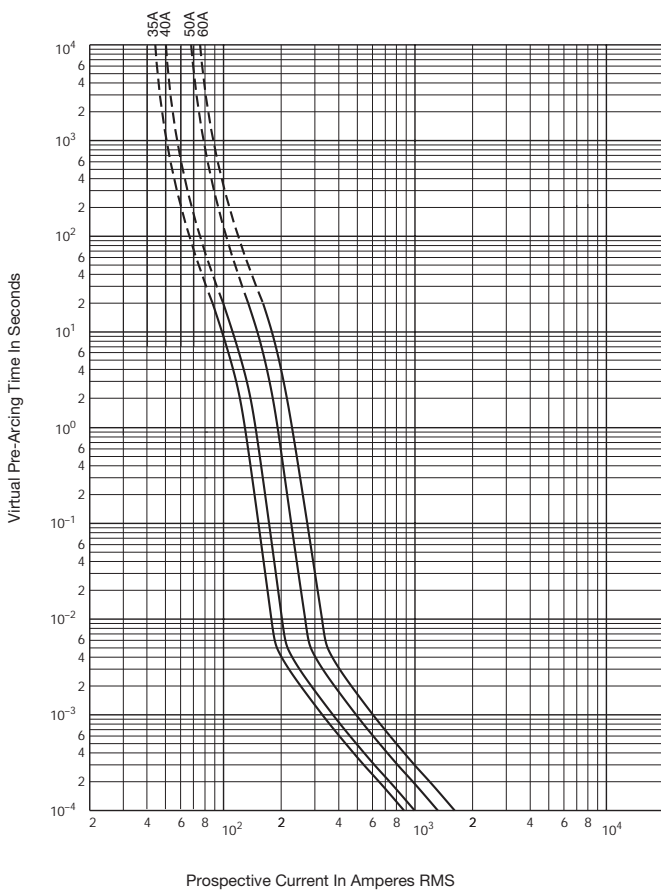

## AS25BG 70-100A: 700V

Time-Current Curve

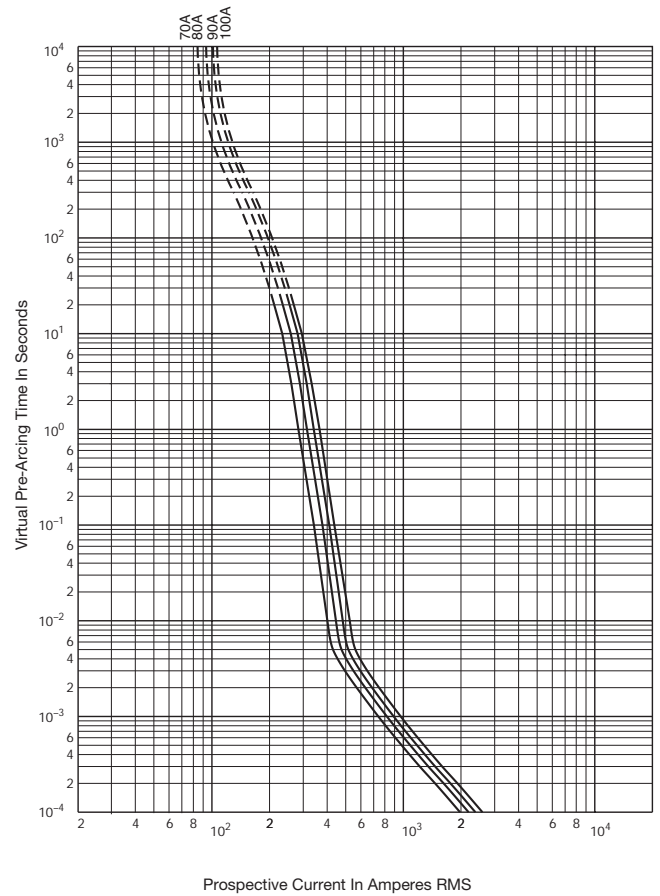

## Peak Let-Through Curve

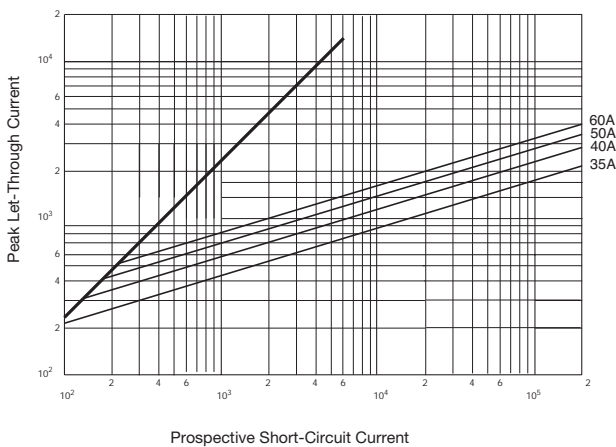

## Peak Let-Through Curve

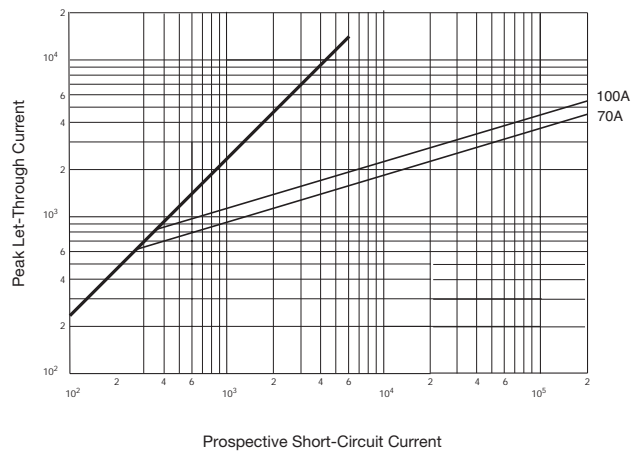

## North American round style fuses 700V: 35-1200A

### AS38BG 125-200A: 700V

Time-Current Curve

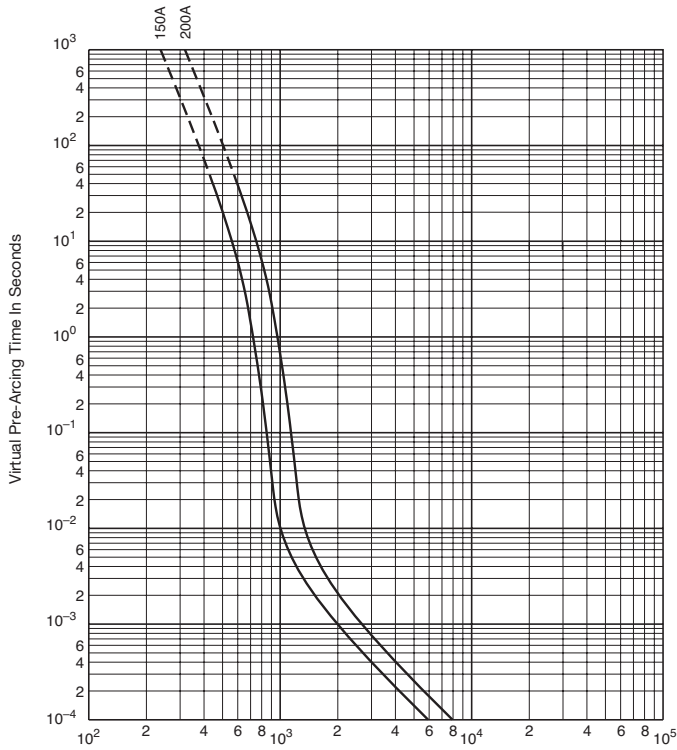

Prospective Current In Amperes RMS

### AS51BG 225-400A: 700V

Time-Current Curve

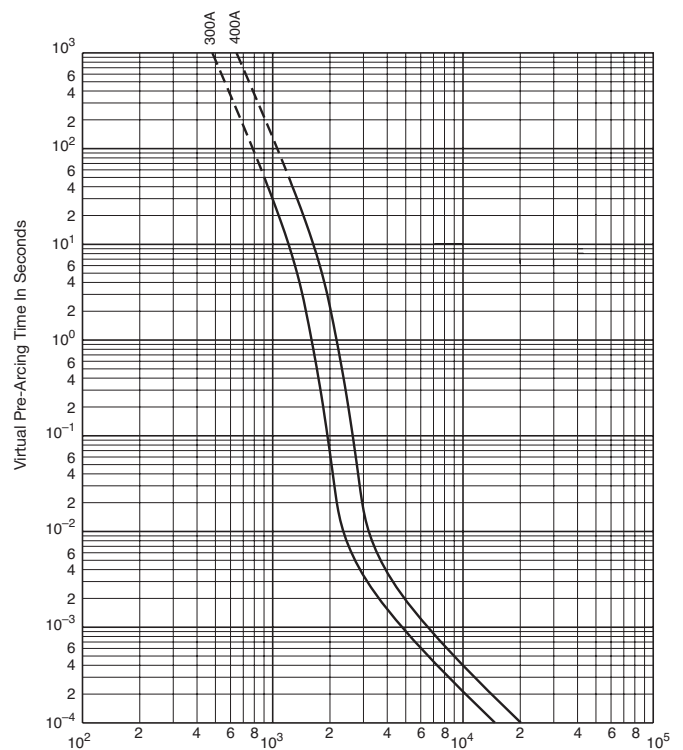

Prospective Current In Amperes RMS

### Peak Let-Through Curve

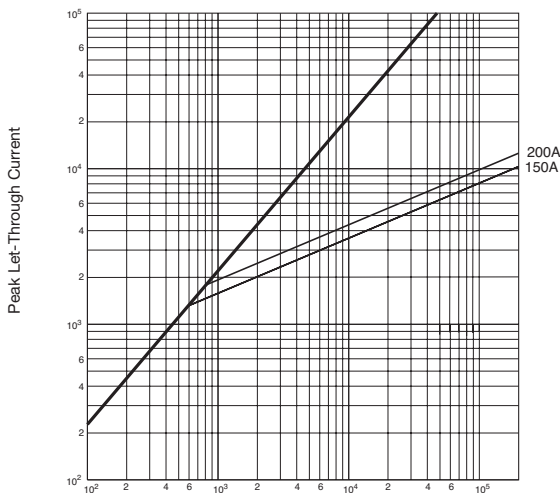

Prospective Short-Circuit Current

### Peak Let-Through Curve

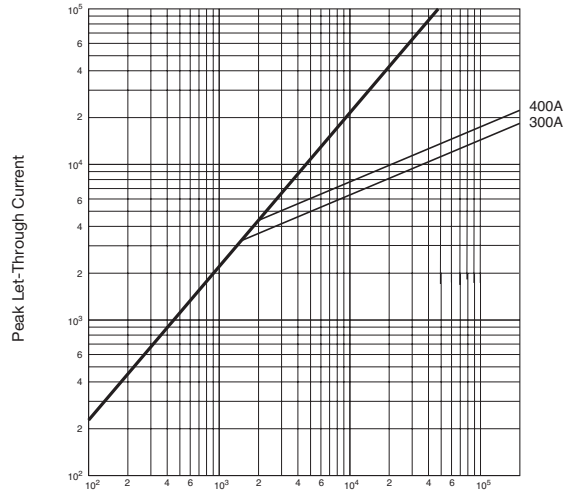

Prospective Short-Circuit Current

**North American round style fuses 700V: 35-1200A**

**AS63BG 450-600A: 700V**

Time-Current Curve

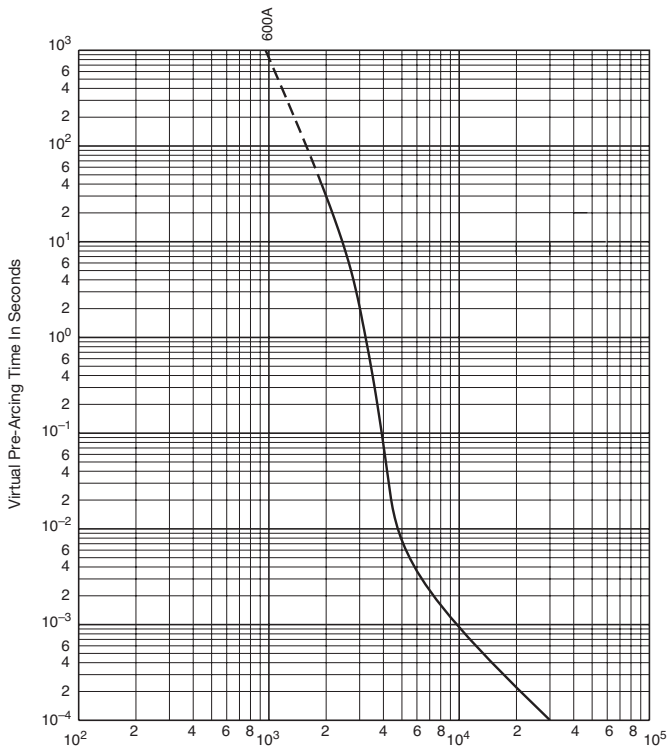

Prospective Current In Amperes RMS

**AS75BG 700-800A: 700V**

Time-Current Curve

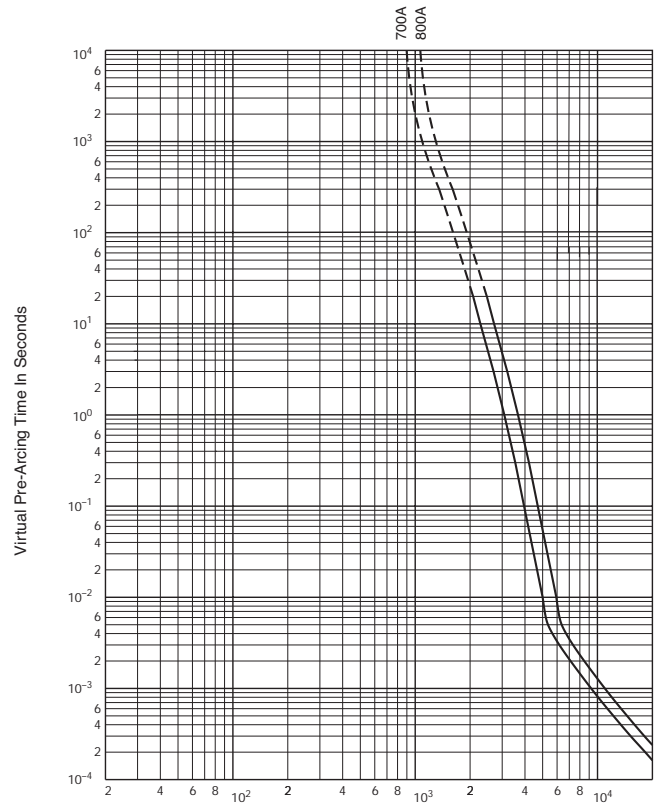

Prospective Current In Amperes RMS

**Peak Let-Through Curve**

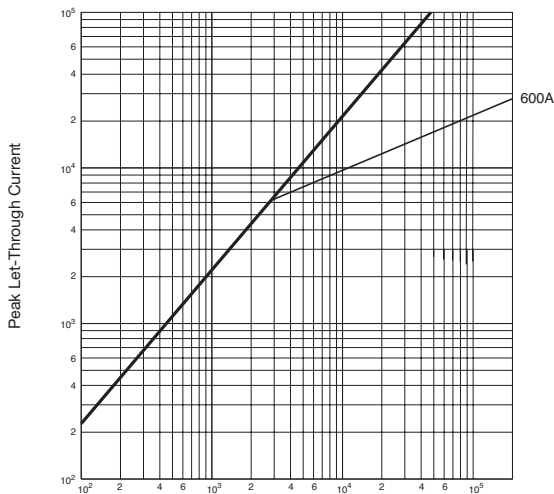

Prospective Short-Circuit Current

**Peak Let-Through Curve**

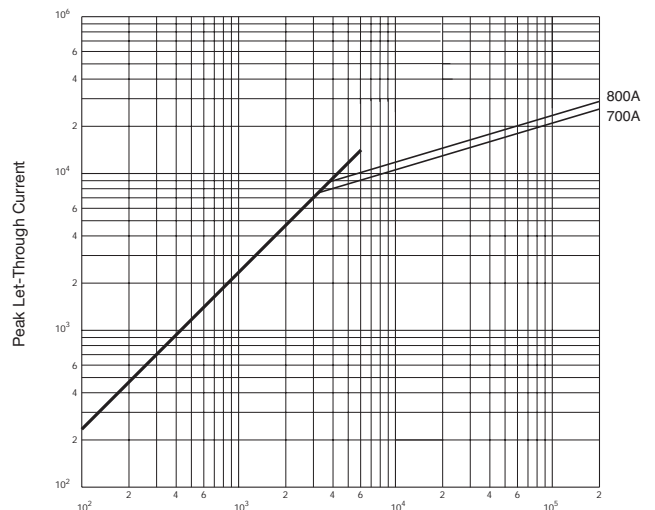

Prospective Short-Circuit Current

**North American round style fuses 700V: 35-1200A**

**AS89BG 900-1000A: 700V**

Time-Current Curve

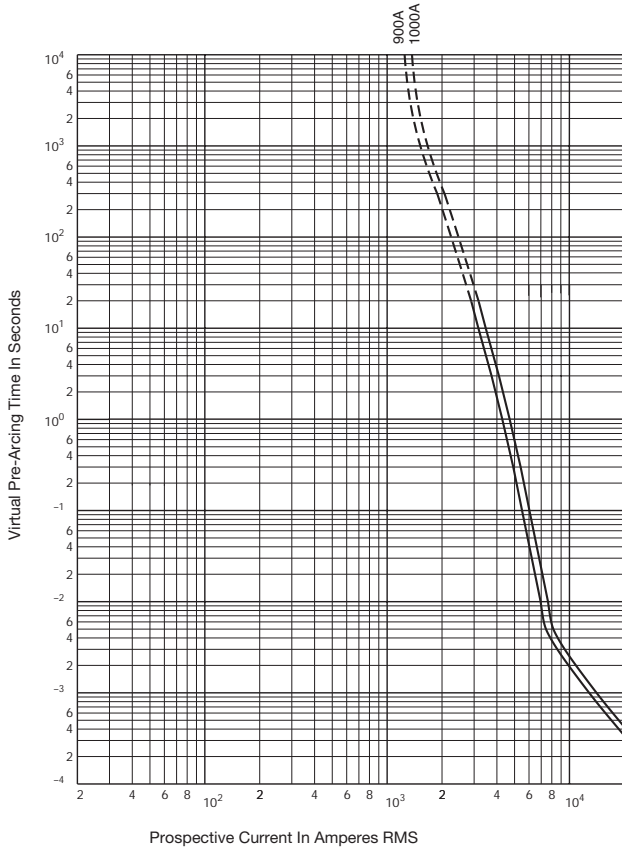

**AS108BG 1200A: 700V**

Time-Current Curve

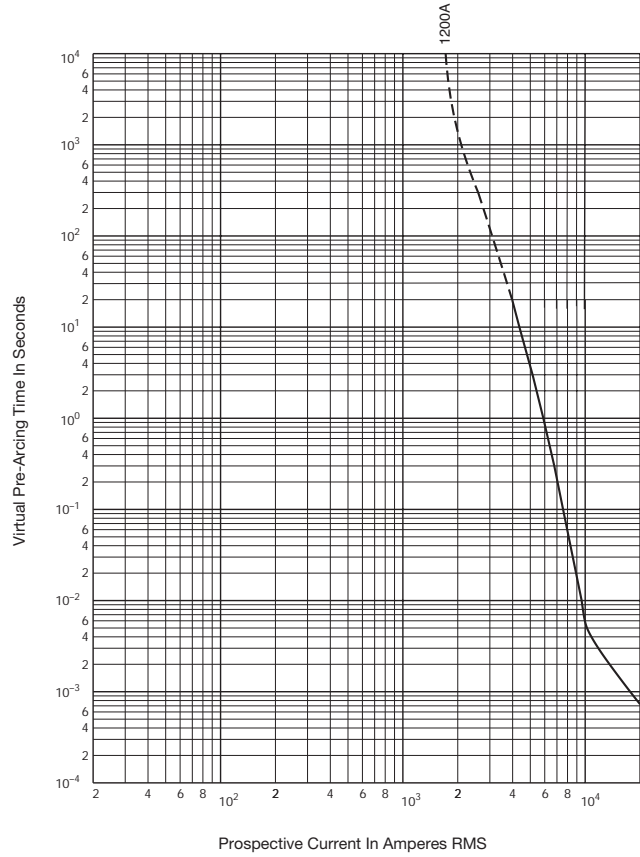

**Peak Let-Through Curve**

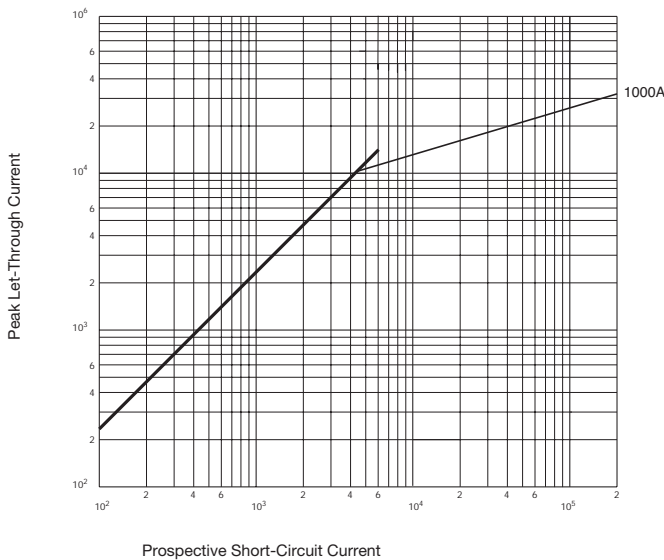

**Peak Let-Through Curve**

